

TC Series Temperature Controller



- * High Reliability by S.M.T. & TQC.
- * With Cold Junction Compensation, Suited to Operated at -20 C ~ +60 C
- * All type with Sensor Break Alarm LED.
- * With P+D Control to Control Temperature Easily.
- * High Accuracy of Displaying & Setting Less than 0.5% of F.S.
- * With Stand-by/Over-heat Alarm.(Optioned).
- * With Heater Break Alarm.(Optioned).
- * 表面貼焊技術及全面品管，提供最可靠性產品
- * 具冷接點補償，適用於周圍溫度 -20 C ~ +60 C
- * 全機種具有測溫體斷線警報
- * P+D 控制易於控溫
- * 高精度的顯示及設定精度，低於全刻度 0.5%
- * 具有待機 / 過熱警報功能 (選擇機種)
- * 具有加熱器斷線警報功能 (選擇機種)



■ Guiding of Model

Ex. TC - 4896 DA - PT - R3 - F - S - A
 ① ② ③④ ⑤ ⑥⑦ ⑧ ⑨ ⑩

① Product 產品代號

TC = Temperature Controller

② Outline 外型

48 = 48(W) X 48(H) mm X mm
 4896 = 48(W) X 96(H) mm X mm
 72 = 72(W) X 72(H) mm X mm
 96 = 96(W) X 96(H) mm X mm

③ Method of Setting 設定方式

D = Digital Swith
 A = Trimmer

④ Method of Display 顯示方式

A = Analog Deviation Meter
 D = Digital LED Display
 N = Without Display

⑤ Type of Sensor 感溫線種類

PT = RTD PT-100 Ω
 J = J Type Thermocouple
 Non = K Type Thermocouple

⑥ Method of Output 輸出方式

R = Relay (5A/250VAC)
 V = Voltage (20mA/12V)
 L = Linear (4~20mA)

⑦ Range of Setting 設定範圍

Digital Switch

0 = -99 ~ + 99
 1 = 0 ~ +199
 3 = 0 ~ +399
 5 = 0 ~ +599
 9 = 0 ~ +999
 11 = 0 ~ +1199

Trimmer

05 = -50 ~ +50
 1 = 0 ~ +100
 2 = 0 ~ +200
 4 = 0 ~ +400
 6 = 0 ~ +600
 12 = 0 ~ +1200

⑧ Unit of Degree 刻度單位

F = F
 non = C

⑨ Method of Control 控制方式

S = ON/OFF
 non = P+D ON/OFF

⑩ Alarm 警報

A = With Stand-by / Over Heat Alarm
 AH = With Stand-by / Over Heat Alarm
 & Heater Break Alarm
 Non = Without Alarm

General Data & Attachment

TC Series

General Data 共同規格	Sensor Type 感溫線	K < CA > , J < IC > or PT-100 Ω
	Output Method 輸出方式	Relay < 5A / 250VAC > , Voltage < 20mA / 12V > , Linear < 4~20mA >
	Control Method 控制方式	P+D ON/OFF , ON/OFF or Proportion
	Proportion Band 比例帶	Appro 2.5% of F.S.
	Cycle Time 動作週期	2 Sec or 20 Sec < ON+OFF >
	Manual Reset 偏移修正	Trimmer., Range ±10 °
	Unit of Degree 單位	°C or °F
AL Alarm AL警報	Setting Method 設定方式	Trimmer (AL)
	Setting Range 設定範圍	0 ~ +50° , 0 ~ -50° or -50° ~ +50° of Setting Value
	Output Method 輸出方式	Relay , 0.5A/250VAC
HB Alarm Hb警報	Setting Method 設定方式	Trimmer (HB)
	Setting Range 設定範圍	0.5A~25A ; 1.0A~50A
	Output Method 輸出方式	Relay , 0.5A/250VAC
Electrical Data 電氣規格	Power Supply 工作電壓	110 / 220 VAC±20% 50 / 60Hz
	Current Consumption 耗電流	2.5VA max.
	Insulation Resistance 絕緣阻抗	Over 50M Ω /500 VDC Between Power And Another Terminal
	Dielectrical Strength 耐壓強度	Over 2.5KV / 1min Between Power And Another Terminal
Mechanical Data 機械規格	Operating Temp./Hum 工作環境	-20°C ~+60°C ; 35%~85% RH
	Vibration Resistance 耐振動	10~55Hz / 1.5mm , 2Hrs in X.Y.Z Direction
	Panel Thickness 面板厚度	1.0~8.0mm

Attachment/附件

CT provided with Heater Break Alarm type only.
只有加熱器斷線警報功能機種附 CT

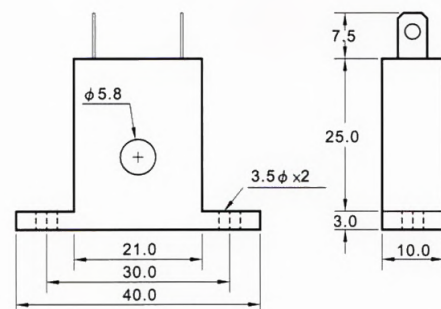

TC-4896 Series

DIN 48X96 Temperature Controller

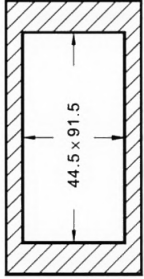
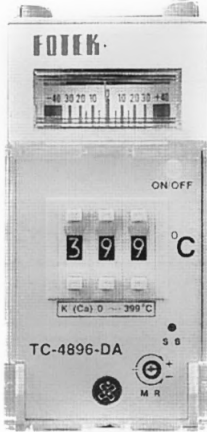
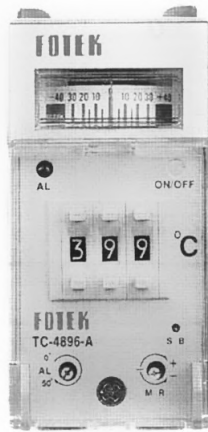
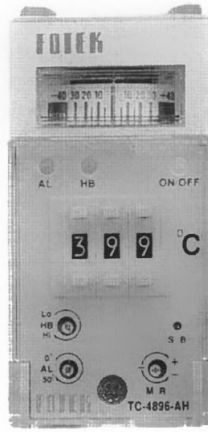
	Model	TC-4896-DA-□ -□	TC-4896-DA-□ -□ -A	TC-4896-DA-□ -□ -AH
	DIN48 X 96 			
	Alarm 警報	Non	AL Alarm	AL+HB
Display 顯示方式	Method 方式	Analog Deviation Meter		
	Tolerance 誤差	1.0% of F.S.		
	Range 範圍	± 40°		
Setting 設定方式	Method 方式	Digital Switch < 3 Digits >		
	Tolerance 誤差	0.5% of Setting Range		
	Range 範圍	-99~+99 , 0~199 , 0~399 , 0~599 , 0~999		

AlltronicsPeru
AUTOMATIZACION INDUSTRIAL

Dimension & Fixed Hole / 外型及固定孔尺寸

Outline

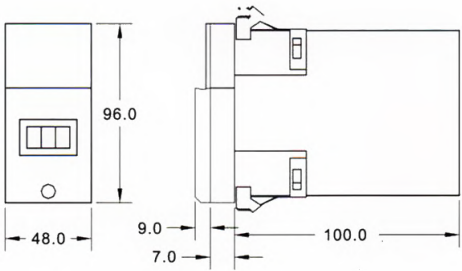

Fixed Hole (Thickness 1~8mm)

Single Cutout Multi Juxtaposed Cutout

單個開孔 多個並排開孔

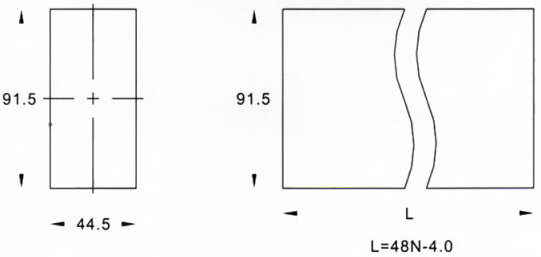



L=48N-4.0

N	2	3	4	5	6
L	92.0	140.0	188.0	236.0	284.0

DIN 72X72 Temperature Controller

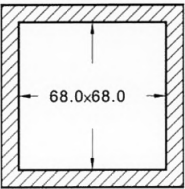
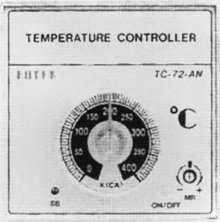
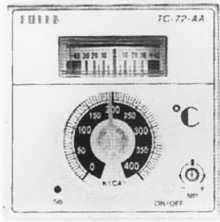
TC-72 Series

	Model	TC-72-AN-□ -□	TC-72-AA-□ -□	TC-72-AA-□ -□ -A
Outline 外型	DIN72 X 72 			
	Alarm 警報	Non	Non	AL Alarm
Display 顯示方式	Method 方式	Non	Analog Deviation Meter	
	Tolerance 誤差	Non	1.0% of F.S.	
	Range 範圍	Non	± 40°	
Setting 設定方式	Method 方式	Trimmer < Variable Resister >		
	Tolerance 誤差	1.0% of Setting Range		
	Range 範圍	0~100 , 0~200 , 0~400 , 0~600 , 0~1200		

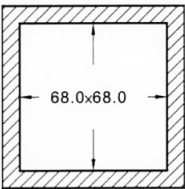
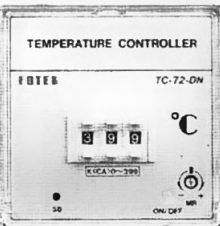
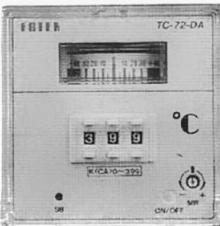
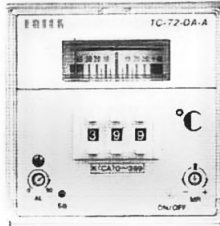

	Model	TC-72-DN-□ -□	TC-72-DA-□ -□	TC-72-DA-□ -□ -A
Outline 外型	DIN72 X 72 			
	Alarm 警報	Non	Non	AL Alarm
Display 顯示方式	Method 方式	Non	Analog Deviation Meter	
	Tolerance 誤差	Non	1.0% of F.S.	
	Range 範圍	Non	± 40°	
Setting 設定方式	Method 方式	Digital Switch		
	Tolerance 誤差	0.5% of Setting Range		
	Range 範圍	-99 ~+99 , 0~199 , 0~399 , 0~599 , 0~999 , 0~1199		

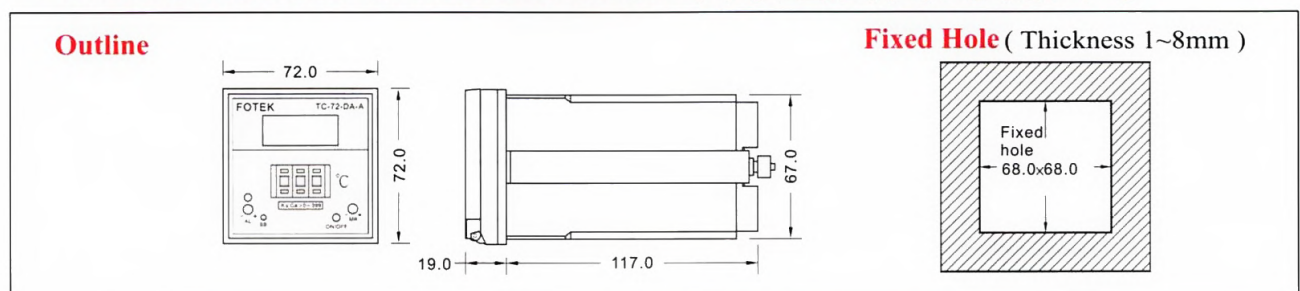
Dimension & Fixed Hole/外型及固定孔尺寸

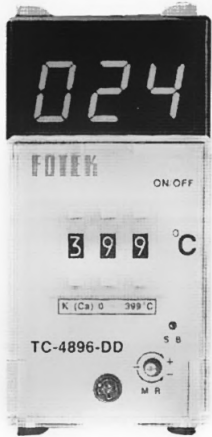

DIN 48X96 Temperature Controller

TC-4896 Series

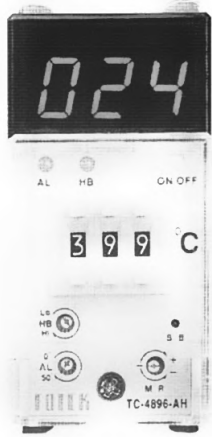
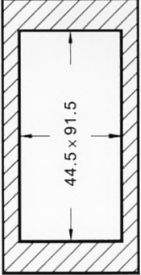
	Model	TC-4896-DD-□ -□	TC-4896-DD-□ -□ -A	TC-4896-DD-□ -□ -AH
Outline 外型	DIN48 X 96			
				
Alarm 警報		Non	AL Alarm	AL+HB
Display 顯示方式	Method 方式	14 mm 7 Segment Red LED		
	Tolerance 誤差	0.5% of F.S. + 1 Digit		
	Range 範圍	-99~+99 , 0~999		
Setting 設定方式	Method 方式	Digital Switch < 3 Digits >		
	Tolerance 誤差	0.5% of Setting Range		
	Range 範圍	-99~+99 , 0~199 , 0~399 , 0~599 , 0~999		



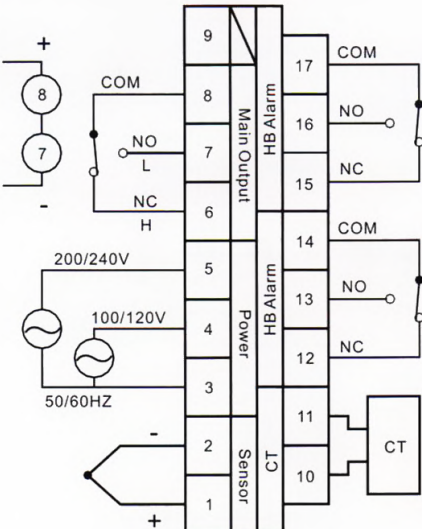
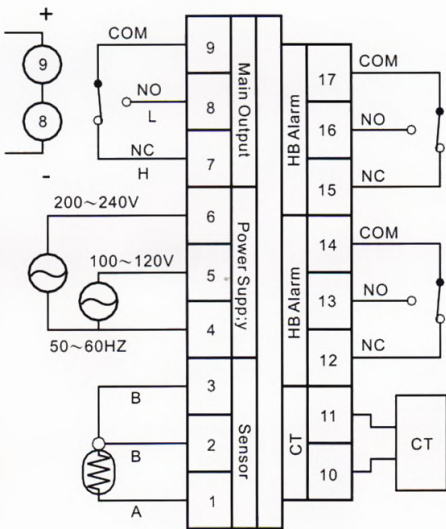
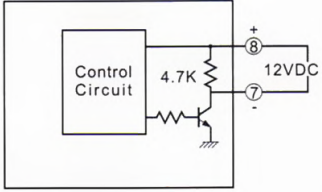
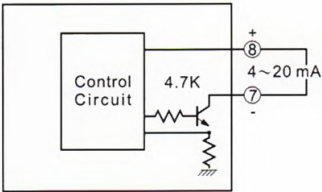

AlltronicsPerú
AUTOMATIZACIÓN INDUSTRIAL



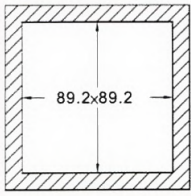

■ Connection Diagram & Output Circuit/接線圖及輸出回路

Thermocouple Type < K or J >	RTD PT-100 Ω Type	Voltage Output
		
		<p>Linear Output</p> 

DIN 96X96 Temperature Controller

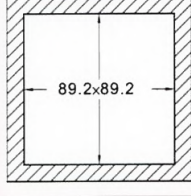
TC-96 Series



	Model	TC-96-AD-□ -□	TC-96-AD-□ -□ -A	TC-96-AD-□ -□ -AH
Outline 外型	DIN96 X 96 			
	Alarm 警報	Non	AL Alarm	AL+HB Alarm
Display 顯示方式	Method 方式	14mm 7 Segment Red LED		
	Tolerance 誤差	0.5% of F.S.		
	Range 範圍	-99 ~+99 , 0~999 , 0~1200		
Setting 設定方式	Method 方式	Trimmer < Variable Resister >		
	Tolerance 誤差	1.0% of F.S.		
	Range 範圍	-50 ~+50 , 0~100 , 0~200 , 0~400 , 0~600 or 0~1200		

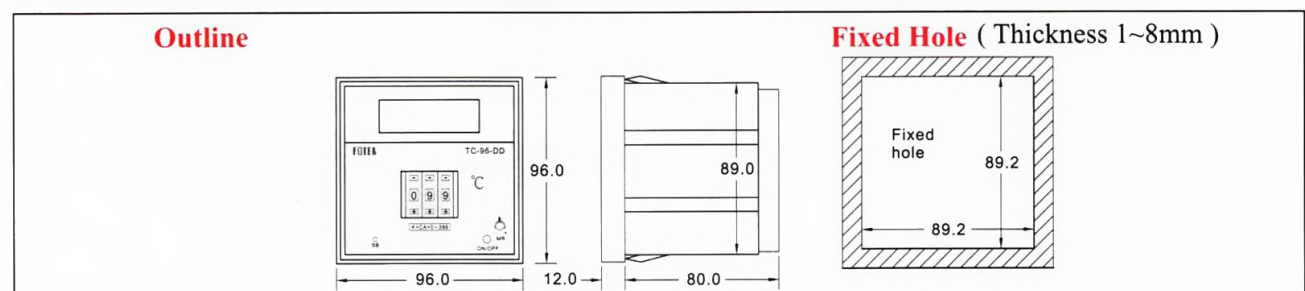

	Model	TC-96-DD-□ -□	TC-96-DD-□ -□ -A	TC-96-DD-□ -□ -AH
Outline 外型	DIN96 X 96 			
	Alarm 警報	Non	AL Alarm	AL+HB Alarm
Display 顯示方式	Method 方式	14mm 7 Segment Red LED		
	Tolerance 誤差	0.5% of F.S.		
	Range 範圍	-99 ~+99 , 0~999 , 0~1200		
Setting 設定方式	Method 方式	Digital Switch		
	Tolerance 誤差	0.5% of F.S.		
	Range 範圍	-99 ~+99 , 0~199 , 0~399 , 0~599 , 0~999 , 0~1199		

■ Dimension & Fixed Hole / 外型及固定孔尺寸



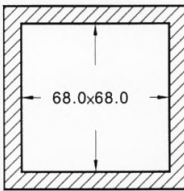

TC-72 Series

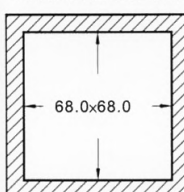

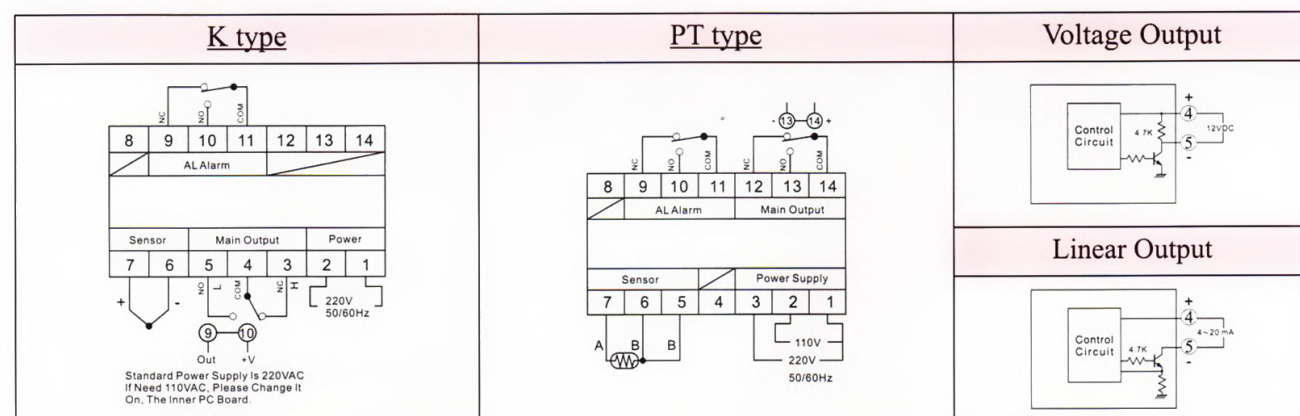
	Model	TC-72-AD-□ -□	TC-72-AD-□ -□ -A
Outline 外型	DIN72 X 72		
			
	Alarm 警報	Non	AL Alarm
Display 顯示方式	Method 方式	14mm 7 Segment Red LED	
	Tolerance 誤差	0.5% of F.S.	
	Range 範圍	0~999 or 0~1999	
Setting 設定方式	Method 方式	Trimmer < Variable Resister >	
	Tolerance 誤差	1.0% of F.S.	
	Range 範圍	0~100 , 0~200 , 0~400 , 0~600 , 0~1200	

	Model	TC-72-DD-□ -□	TC-72-DD-□ -□ -A
Outline 外型	DIN72 X 72		
			
	Alarm 警報	Non	AL Alarm
Display 顯示方式	Method 方式	14mm 7 Segment Red LED	
	Tolerance 誤差	0.5% of F.S.	
	Range 範圍	-99~99 , 0~999 or 0~1999	
Setting 設定方式	Method 方式	Digital Switch	
	Tolerance 誤差	0.5% of Setting Range	
	Range 範圍	-99 ~+99 , 0~199 , 0~399 , 0~599 , 0~999 , 0~1199	

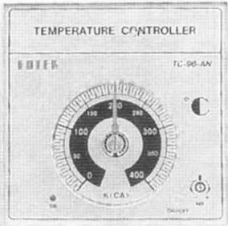

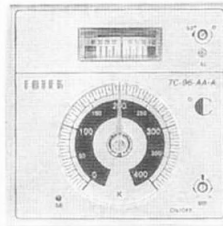
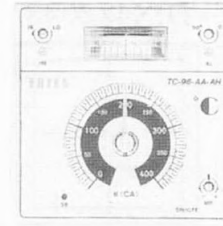
TC-96 Series



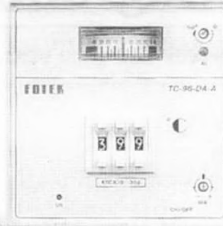
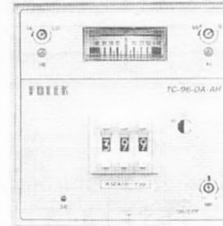

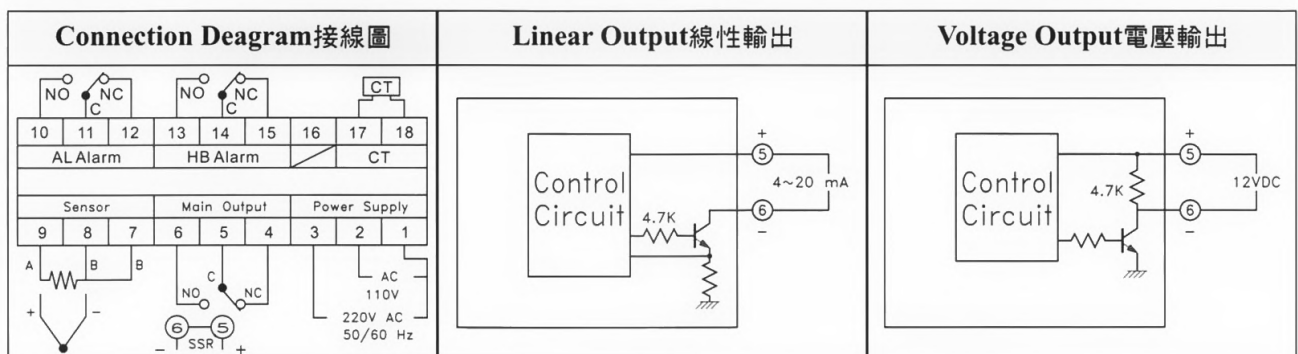
TC-96-AN-□ □	TC-96-AA-□ □	TC-96-AA-□ □ -A	TC-96-AA-□ □ -AH
			
Non	Non	AL Alarm	AL+HB Alarm
Non	Analog Deviation Meter		
Non	1.0% of F.S.		
Non	$\pm 40^\circ$		
Trimmer < Variable Resister >			
1.0% of F.S.			
-50 ~+50 , 0~100 , 0~200 , 0~400 , 0~600 or 0~1200			

TC-96-DN-□ □	TC-96-DA-□ □	TC-96-DA-□ □ -A	TC-96-DA-□ □ -AH
			
Non	Non	AL Alarm	AL+HB Alarm
Non	Analog Deviation Meter		
Non	1.0% of F.S.		
Non	$\pm 40^\circ$		
Digital Switch			
0.5% of F.S.			
-99 ~+99 , 0~199 , 0~399 , 0~599 , 0~999 , 0~1199			

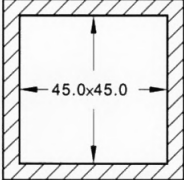

TC-48 Series

DIN 48X48 Temperature Controller

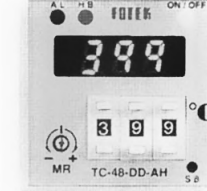
Model	TC-48-AN-□ □	TC-48-DN-□ □	TC-48-DD-□ □	TC-48-DD-□ □ -AH
Outline 外型	    			
Alarm 警報	Non	Non	Non	AL+HB Alarm
Display 顯示方式	Method 方式	Non	Non	0.36" 7-Segment Red LED
	Tolerance 誤差	Non	Non	0.5% of F.S.
	Range 範圍	Non	Non	-99~+99 , 0~999
Setting 設定方式	Method 方式	Trimmer	Digital Switch	
	Tolerance 誤差	1.0%	0.5% of Setting Range	
	Range 範圍	100 , 200 , 400	-99 ~+99 , 0~199 , 0~399 , 0~599 , 0~999	

■ Connection Diagram/接線圖

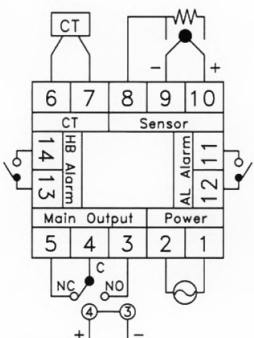
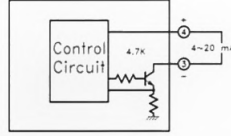
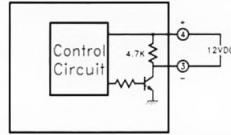
K / J & PT-100 Type	Linear Output
 <p>Standard Power Supply Is 220VAC , If Need 110VAC , Please Change It On The Inner PC Board.</p> <p>標準工作電壓是220VAL , 如果要用110VAL , 可在 基板上變更。</p>	
	<p>Voltage Output</p> 

■ Dimension & Fixed Hold/外型及固定孔尺寸

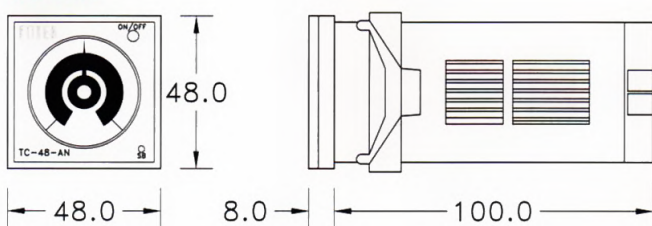
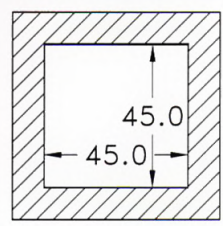
<p>Outline</p> 	<p>Fixed Hole (Thickness 1~8mm)</p> 
---	--

DIN 48X48 Temperature Controller

H5-AN series

- ☆ DIN 48X48
- ☆ All Type With Sensor Break Alarm LED
全機種附斷線警報指示燈
- ☆ With Cold Junction Compensation, Suited To Operated At -20°C ~ +60°C.
附冷接點補償，適用-20°C ~ +60°C
- ☆ Setting Accuracy Less Than 1.0% of F.S.
設定精度少於1.0%
- ☆ With P+D Control To Control Temperature Easily.
PFD控制方式，可精確控溫



■ Specification/規格

Model型號	H5 - AN - □ □ - □
Sensor Type感溫線	K<CA>orJ<IC>or PT-100Ω
Control Method控制方式	P+D ON/OFF or ON/OFF
Output Method輸出方式	Relay < 5A/250 VAC > or Voltage < 20 mA/12V >
Cycle Time動作週期	2 sec or 20 sec
Degree Unit單位	°C
Power Supply工作電壓	110 / 220 VAC 20%, 50/60Hz
Current Consumption耗電流	2.5 VA max.
Insulation Resistance絕緣阻抗	100MΩ / 500 VDC
Dielectric Strength耐壓強度	2.5 KV / 1 min
Vibration Resistance抗振動	10~55 Hz/1.5mm, 2Hrs
Operating Temp/Hum工作環境	-20 ~+60 C; 35%~85% RH
Weight重量	Appr. 185g

■ Guiding of Model/型號索引

H5 - AN - PT - R 4 - S

① ② ③ ④ ⑤ ⑥

- ① **Series 系列**
H5 series
- ② **Method of Setting 設定方式**
AN = Trimmer Type
- ③ **Type of Sensor**
NOU = K Type
J = J Type
PT = PT Type
- ④ **Method of Output 輸出方式**
R = Relay < 5A/250 VAC >
V = Voltage < 20mA/12 VDC >
- ⑤ **Range of Setting 設定範圍**
1 = 0 ~ 100
2 = 0 ~ 200
4 = 0 ~ 400
- ⑥ **Method of Control 控制方式**
Non = P+D ON / OFF
S = ON / OFF

■ Dimension/外型尺寸

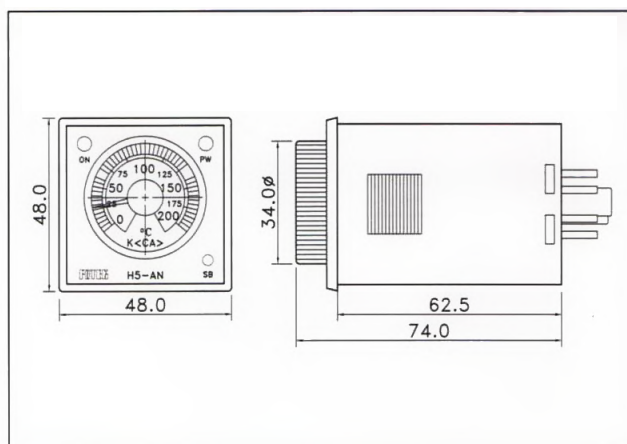

■ Connection Diagram/接線圖

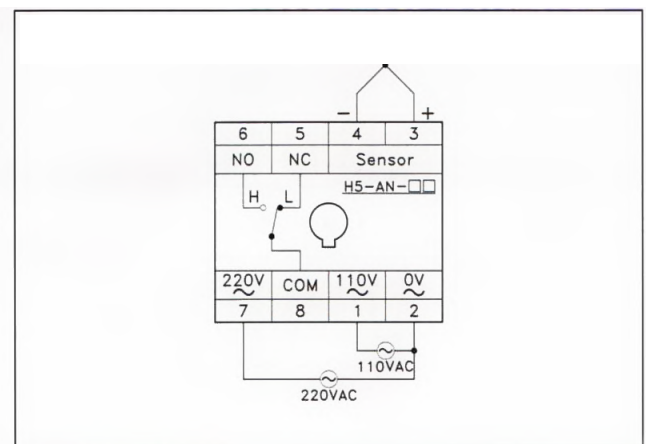

Notice

■ Notice of Use / 使用注意事項

1. Please Install The Temperature Controller In The Circumstance

Temperature: $-20^{\circ}\text{C} \sim +75^{\circ}\text{C}$ (Without Icing or Condensation)

Humidity: $35\% \sim 85\% \text{RH}$

The high Ambient Temperature May Shorten The Service Life of Temperature Controller, Please Don't Let It Exceed 75°C

溫度控制器安裝環境

溫度: $-20^{\circ}\text{C} \sim +75^{\circ}\text{C}$ (無結冰或結露)

濕度: $35\% \sim 85\% \text{RH}$

高溫環境可能縮短溫度控制器壽命，請不要讓工作的環境溫度超過 75°C

2. The Service Life of Relays Are Affected By The Switching Load.

Please Assure The Switching Load Are Under The Rated Current.

繼電器壽命受工作負載影響很大，請勿超載使用。

3. Thermcouple Type, If Need To Extend The Thermcouple Lead Wire Please Be Sure To Use The Compensation Wires That Must To Match The Thermcouple Type.

PT Resistance Type, If Need To Extend The PT Sensor Lead Wire Please Be Sure To Use The Low Resistance Wire.

熱電偶感溫線，如果須延長時務必使用同規格的補償導線。

白金電阻型感溫線，如果須延長時務必使用低阻抗電線。

4. The Lead Wire of Temperature Sensor, Please Separate It Away From The Power Lines or High Tension Lines To Avoid Noise Interruption.

感溫線請勿與和高壓線或動力線結紮在一起。

5. It is Suggested To Settle The Separated Alarm System, In Case of The Alarm of Temperature Controller May Not Be Operated Properly When The Device is Abnormal.

建議設置獨立的警報系統，以免溫控器異常時警報器功能失效。

6. The Temperature Controller May Be Interrupted By Movable Phone or Wireless Device.

溫控器可能會受行動電話或無線發射器干擾。

7. Outline of Crimp Terminal 端子夾外型



■ Notice Of Safety/安全注意事項

Definition of Symbol Marks



WARNING

Potentially Hazardous Situation
In Case Of Mishandling,May Result In Death
Or Serious Injury
潛在危險
如果操作失誤，有可能導致死亡或嚴重傷害。



CAUTION

Potentially Hazardous Situation
In Case of Mishandling,May Result In Slight Dangerous.
潛在危險
如果操作失誤，有可能導致輕微傷害。



WARNING

- 1.Please Do Not Touch The Terminals While The Power Is Supplied, If Do,It May Result In Electronic Shock.
送電中，請勿碰觸接線端以免觸電。
- 2.Please Do Not Let The Metal or Wire Cuttings Drop Into The Insid of Temperature Controller, If Do,It May Resule In Malfunction,Burnning Out or Fire.
請勿讓鐵屑或鋼絲掉入溫控器內，以免造成溫控器失效，燒毀甚至起火。
- 3.Please Make Sure To Wire The Temperature Controller Correctly Before Power ON,If Not, It May Result In Malfunction or Burnning out.
送電前請確認配線是否正確，否則可能導致異常或燒毀。
- 4.Please Do Not Modify or Repair The Temperature Controller,To Avoid Resulting In Malfunction or Burnning out.
請勿修改或修理溫控器，以免造成異常燒毀。



CAUTION

- 1.Please Rate The Power Supply Voltage Wirhin The Specified Range,If Not,It May Result In Malfunction or Burnning.
工作電壓請限制在規格內，否則可能造成溫控器異常或燒毀。
- 2.Please Rate The Load Within The Specified Value,If Not,It May Result In Malfunction or Burnning.
工作負載請勿超過額定電流，否則可能造成溫控器異常或燒毀。
- 3.Please Settle a Seperated Alarm Syatem To Ensure Safety Protection In The Event of Malfunction,If Not,It May Result In A Serious Accident.
請設置獨立警報系統，確保溫控器異常時安全保護，否則可能造成嚴重意外事故。